



# PROMOZIONE

“L’inizio di una nuova era”

2011



No. **250**

**PRODOTTI IN OFFERTA!**



## 002 GV6

### E010109P

6 cassetti: 3 di altezza 60 mm, 2 di altezza 130 mm, 1 di altezza 210 mm  
 Ogni cassetto può alloggiare 3 moduli porta utensili  
 Apertura del cassetto a estrazione totale  
 Portata statica per cassetto:  
 15 kg per i cassetti alti 60 mm, 20 kg per i cassetti alti 130 mm e 210 mm  
 Chiusura centralizzata  
 Piano di lavoro in tecnopolimero ABS ad alta resistenza e sostituibile  
 Portata statica del piano di lavoro: 600 kg  
 Impugnatura in metallo  
 4 ruote diametro 125 mm di cui una con dispositivo di blocco  
 Dimensioni esterne (maniglia inclusa): L.800 x P.500 x H.987 mm  
 Dimensioni esterne (maniglia esclusa): L.715 x P.500 x H.987 mm  
 Superficie utile dei cassetti: L.569 x P.420 mm

€ 541,00 **€ 319,00**

## 002 GV7

### E010105P

7 cassetti: 4 di altezza 60 mm, 3 di altezza 130 mm  
 Ogni cassetto può alloggiare 3 moduli porta utensili  
 Tutti i cassetti sono dotati di tappetini in gomma anti scivolo  
 Apertura del cassetto a estrazione totale  
 Portata statica per cassetto:  
 15 kg per i cassetti alti 60 mm, 20 kg per i cassetti alti 130 mm  
 Chiusura centralizzata  
 Piano di lavoro in tecnopolimero ABS  
 ad alta resistenza e sostituibile  
 Portata statica del piano di lavoro: 600 kg  
 Impugnatura in metallo  
 4 ruote diametro 125 mm di cui una con dispositivo di blocco  
 Dimensioni esterne (maniglia inclusa): L.800 x P.500 x H.987 mm  
 Dimensioni esterne (maniglia esclusa): L.715 x P.500 x H.987 mm  
 Superficie utile dei cassetti: L.569 x P.420 mm

€ 754,00 **€ 349,00**



## 007 GVL

### E010101P

7 cassetti: 4 di altezza 60 mm, 3 di altezza 130 mm  
 Ogni cassetto può alloggiare 4 moduli porta utensili  
 Apertura del cassetto a estrazione totale  
 Portata statica per cassetto:  
 20 kg per i cassetti alti 60 mm, 25 kg per i cassetti alti 130 mm  
 Chiusura centralizzata  
 Piano di lavoro in tecnopolimero ABS ad alta resistenza e sostituibile  
 Portata statica del piano di lavoro: 800 kg  
 Impugnatura in metallo  
 4 ruote diametro 125 mm di cui una con dispositivo di blocco  
 Dimensioni esterne (maniglia inclusa): L.1005 x P.500 x H.987 mm  
 Dimensioni esterne (maniglia esclusa): L.920 x P.500 x H.987 mm  
 Superficie utile dei cassetti: L.760 x P.420 mm

€ 791,00 **€ 475,00**











## 002 GV7 - 764 1/4-1/2 E98

802GV705

Carrello 7 cassettei 002 GV7 con cassetta assortita di bussole e accessori 1/4"-1/2" (98 pezzi)

€ 929,00 **€ 446,00**

### Assortimento di 98 bussole e accessori

descrizione	art./mis.	pz.
bussole esagonali 1/4"	4-5-5,5-6-7-8-9-10-11-12-13	11
bussole esagonali lunghe 1/4"	6-8-10-11-12-13-14	7
inserti Torx 1/4"	T6-T8-T10	3
bussole con inserto 1/4" 	4-7	2
bussole con inserto Torx 1/4" 	T8-T10-T15-T20-T25-T27-T30	7
bussole con inserto Phillips 1/4" 	PH1-PH2	2
bussole con inserto Pozidriv 1/4" 	PZ1-PZ2	2
bussole con inserto esagonale 1/4"	3-4-5-6	4
cricchetto 1/4"		1
prolunghe 1/4"	55-100	2
snodo cardanico 1/4"		1
leva a T 1/4"		1
impugnatura con quadro maschio 1/4"		1
bussole esagonali 1/2"	10-11-12-13-14-15-16-17-18-19-20-21-22-24-27-30-32	17
bussole esagonali lunghe 1/2"	14-15-17-19-22	5
bussole per candele 1/4"	16-21	2
bussole Torx 1/2"	E12-E14-E16-E18-E20-E24	6
cricchetto 1/2"		1
aumentatore 3/8"-1/2"		1
bussola 1/2" portainseri 5/16"		1
prolunghe 1/2"	130-250	2
snoda cardanico 1/2"		1
inserti XZN 5/16"	6-8-10-12	4
inserti 5/16" 	8-12	2
inserti Torx 5/16" 	T40-T45-T50-T55	4
inserti Phillips 5/16" 	PH3-PH4	2
inserti Pozidriv 5/16" 	PZ3-PZ4	2
inserti esagonali 5/16" 	8-10-12-14	4

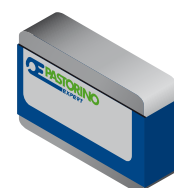



## 002 GV7 - JMB2

802GV706

Carrello 7 cassetti 002 GV7 con assortimento di 80 utensili in vaschette termoformate

€ 1.398,00 € 673,00



### Assortimento di 80 utensili

descrizione	art./mis.	vaschetta
chiavi combinate 83 N	6-7-8-9-10-11-12-13-14-15-16-17-18-19-22-24	K 83
serie 9 chiavi maschio esagonali	1,5÷10	K 83P
pinza becchi mezzotondi lunghi diritti zigrinati	282 A 160	K 301
pinza universale	301 A 180	K 301
tronchese a tagliente diagonale	357 A 160	K 301
pinza regolabile	514 250	K 301
pinza regolabile autobloccante	521 180	K 301
pinza per anelli elastici interni becchi diritti	331 N 19÷60	K 332
pinza per anelli elastici interni becchi piegati	332 N 19÷60	K 332
pinza per anelli elastici esterni becchi diritti	333 N 19÷60	K 332
pinza per anelli elastici esterni becchi piegati	334 N 19÷60	K 332
martelli per meccanici	398 500	K 398
mazzuola	399 P 32	K 398
cacciaspine	536 4-6-8	K 398
bulino	534 6	K 398
scalpello	532 24	K 398
giraviti per viti con intaglio	384 3x75-4x100-5,5x125-6,5x150-8x175	K 384
giraviti per viti con impronta Phillips®	384 PH 0-1-2	K 384
giraviti tipo corto per viti con impronta Phillips®	384 NPH 2	K 384
giraviti tipo corto per viti con intaglio	384 N 4x30	K 384
chiavi maschio esagonali con impugnatura	528 P 2,5-3 528 TS P 4-5-6-7-8-10	K 528
bussole 1/2"	30 1/2" 8-10-11-12-13-14-15-16-17-18-19-21-22-23-24-27-30-32	K 762 1/2" R
cricchetto reversibile 1/2"	31 1/2" R	K 762 1/2" R
prolunga 1/2"	32 1/2" 250	K 762 1/2" R
snodo cardanico 1/2"	34 1/2"	K 762 1/2" R



**001 S**

**801SV000**

Vani superiori scorrevoli con piani di lavoro protetti da tappetini in gomma antiolio  
Chiusura con lucchetto  
Vascone interno con divisori in lamiera e vaschetta scorrevole  
Vani laterali porta oggetti  
Maniglione antiurto rivestito in gomma  
Ruote in gomma antiolio:  
- 2 ruote pivotanti, di cui una con freno, da  $\varnothing$  100 mm  
- 2 ruote fisse da  $\varnothing$  125 mm  
Portata max: 280 Kg  
Verniciato a polveri epossidiche  
Dimensioni chiuso: 940x560x880 mm

~~€ 890,00~~ **€ 534,00**

**K 81**



**1K810001**

Chiavi a forchetta doppie **81 N** 6x7-8x9-10x11-12x13-14x15-16x17-18x19-20x22

~~€ 43,70~~

**€ 26,00**

**K 81 A**



**1K81A001**

Chiavi a forchetta doppie **81 N** 21x23-24x27-25x28-30x32

~~€ 42,05~~

**€ 25,00**

**K 83**

**NEW**



**E194937P**

Chiavi combinate **83 N** 6-7-8-9-10-11-12-13-14-15-16-17-18-19-22-24

~~€ 104,25~~

**€ 65,00**



**K 83 A**

**NEW**



**E110302P**

Chiavi combinate **83 N** 27-29-30-32

~~€ 68,85~~

**€ 41,00**

**K 84**



**1K840001**

Chiavi a T con snodo cardanico **84** 7-8-10-11-13-14-17-19

~~€ 213,40~~

**€ 128,00**

**K 88 P**

**NEW**



**E194939P**

Chiavi a pipa passanti doppie **88 P** 8-10-11-12-13-14-16-17-18-19

~~€ 140,00~~

**€ 84,00**

**K 301**

**1K301001**  
Pinze **282 A** 160,  
**301 A** 180, **514** 250,  
**521** 180 e tronchese  
**357 A** 160

€107,60

€ 64,00

**K 332**

**E194943P**  
Pinze per anelli elastici  
**331 N** 19÷60,  
**332 N** 19÷60,  
**333 N** 19÷60,  
**334 N** 19÷60

€74,35

€ 45,00

**K 384**

**1K384001**  
Giraviti **384** 3x75-4x100-  
5,5x125-6,5x150-8x175,  
**384 PH** 0-1-2, **384 NPH** 2,  
**384 N** 4x30

€53,05

€ 32,00

**K 398****NEW**

**E150802P**  
Martello **398** 500,  
mazzuola **399 P** 32,  
cacciaspine **536** 4-6-8,  
bulino **534** 6,  
scalpello **532** 24

€74,65

€ 45,00

**K 528****NEW**

**E121201P**  
Chiavi maschio piegate  
con impugnatura  
**528 P** 2,5-3,  
**528TS P** 4-5-6-7-8-10

€64,35

€ 39,00

**K 570**

**1K570001**  
lima piatta **570 A**,  
lima mezzotonda **570 B**,  
lima triangolare **570 C**,  
lima tonda **570 D**,  
lima quadra **570 E**

€56,25

€ 34,00

**K 762 1/4" R**

**E194680P**  
Bussole **1/4"** 4-4,5-5-5,5-  
6-7-8-9-10-11-12-13-14,  
cricchetto **1/4"**, prolunghe  
50-100, quadro maschio,  
snodo cardanico **1/4"**,  
porta bussole  
con impugnatura,  
bussola porta inserti,  
inserti 4-5,5-6,5, PZ 1-2-3, T  
10-15-20-25-30-40, esago-  
nale 3-4-5-6,  
chiavi maschio esagonale  
1,5-2-2,5-3-4-5-6

€86,25

€ 52,00

**K 762 3/8" R**

**E194678P**  
Bussole **3/8"** 7-8-9-  
10-11-12-13-14-15-  
16-17-18-19-20-21-  
22, cricchetto **3/8"**,  
prolunghe **3/8"**  
125-250,  
snodo cardanico

€86,60

€ 31,00

**K 762 1/2" R**

**E194677P**  
Bussole **1/2"**  
8-10-11-12-13-14-  
15-16-17-18-19-21-  
22-23-24-27-30-32,  
cricchetto **1/2"**,  
prolunga **250**,  
snodo cardanico **1/2"**

€129,75

€ 78,00







### 003 CV

**811VM002**

Cassetta in metallo con finiture in polipropilene

Cerniere in metallo

Vaschetta estraibile

Impugnatura rivestita in gomma morbida a scomparsa

Dimensioni: 26"

~~€44,00~~ **€ 26,00**

### 003 CA

**811AS005**

Cassetta in metallo 003 CV  
con assortimento di 28 utensili

~~€181,55~~ **€ 109,00**



#### Assortimento di 28 utensili

descrizione	art./misura	pz.
serie di chiavi a forchetta doppia	<b>81 N</b> 6x7-8x9-10x11-12x13-14x15-17x19	6
metro pieghevole legno	<b>197 A</b>	1
forbice per elettricisti	<b>296 TX</b>	1
pinza universale	<b>301 A</b> 180	1
giraviti per viti con intaglio	<b>384</b> 3x75-4x100-5,5x125-6,5x150	4
giraviti per viti con impronta Phillips®	<b>384 PH</b> 0-1-2	3
martello	<b>398</b> 300	1
pinza regolabile	<b>514</b> 250	1
serie di chiavi maschio esagonale	<b>528 S9</b> 1,5÷10	9
cutter	<b>CUT 1</b> 170	1

### 008 5V

**E194738P**

Cassetta metallica estensibile a 5 scomparti lunghezza 450 mm

2 maniglie articolate

5 scomparti su 3 livelli

Predisposizione per chiusura a lucchetto

Facile da aprire grazie al dispositivo a pantografo

Dimensioni esterne (maniglie incluse): L.490 x P.250 x H. 230 mm

Dimensioni utili dello scomparto inferiore: L.448 x P.200 x H. 98 mm

Dimensioni utili dei 4 scomparti: L.448 x P.100 x H. 55 mm

~~€52,40~~ **€ 31,00**



### 008 L5V

**E010201P**

Cassetta metallica estensibile a 5 scomparti lunghezza 535 mm

2 maniglie articolate

5 scomparti su 3 livelli

Predisposizione per chiusura a lucchetto

Facile da aprire grazie al dispositivo a pantografo

Dimensioni esterne (maniglie incluse): L.575 x P.250 x H. 230 mm.

Dimensioni utili dello scomparto inferiore: L.518 x P.200 x H. 98 mm.

Dimensioni utili dei 4 scomparti: L.518 x P.100 x H. 55 mm.

~~€54,50~~ **€ 33,00**



## 010 L

Banco da lavoro senza cassetti  
Piano in legno multistrato, spessore 30 mm  
Predisposizione per il fissaggio al pavimento  
Struttura in lamiera d'acciaio con verniciatura anaforetica  
4 montanti per le lunghezze 1 m e 1,5 m  
6 montanti per la lunghezza 2 m  
Possibilità di montare il cassetto 010 AH175  
Portata statica:  
L 1000 = 1000 kg  
L 1500 = 1500 kg  
L 2000 = 2000 kg



articolo	codice	L mm	<del>€ 311,00</del>	€ 179,00
010 L10	810LV010	1000	<del>€ 415,00</del>	€ 239,00
010 L15	810LV015	1500	<del>€ 495,00</del>	€ 290,00
010 L20	810LV020	2000		

## 010 M

Banco da lavoro senza cassetti  
Piano in lamiera d'acciaio zincata, spessore 2,5 mm  
Bordi anticaduta sul piano di lavoro  
Predisposizione per il fissaggio al pavimento  
Struttura in lamiera d'acciaio con verniciatura anaforetica  
4 montanti per le lunghezze 1 m e 1,5 m  
6 montanti per la lunghezza 2 m  
Possibilità di montare il cassetto 010 AH175  
Portata statica:  
L 1000 = 1000 kg  
L 1500 = 1500 kg  
L 2000 = 2000 kg



articolo	codice	L mm	<del>€ 219,00</del>	€ 119,00
010 M10	810MV010	1000	<del>€ 307,00</del>	€ 167,00
010 M15	810MV015	1500	<del>€ 377,00</del>	€ 213,00
010 M20	810MV020	2000		

## CASSETTO OPZIONALE PER BANCHI DA LAVORO

Tutti i banchi con pianale in legno o acciaio possono montare il cassetto opzionale.



## 010 AH175

810AH004  
Cassetto con guide per banchi 010 L e 010 M  
Serratura con chiavi inclusa  
Dimensioni interne: 570x420x175 mm  
Compatibile con moduli portautensili

~~€ 130,00~~ € 66,00



## 762 3/4" R

**76234R01**

Assortimento in cassetta di lamiera con cricchetto 31 3/4" R  
Dimensioni: 470x230x90 mm

€ 410,00 **€ 246,00**



### Assortimento di 15 utensili

descrizione	art./mis.	pz.
chiavi a bussola bocca esagonale	30 N 3/4" 22-24-27-28-30-32-34-36-38-41-46	11
cricchetto reversibile	31 3/4" R	1
quadro maschio	33 N 3/4"	1
prolunga	32 N 3/4" 200-380	2

### Assortimento di 22 utensili

descrizione	art./mis.	pz.
bussole esagonali 3/8"	6-7-8-9-10-11-12-13-14-15-16-17-18-19-21-22-24	17
cricchetto 3/8"		1
prolunghe 3/8"	75-125	2
snodo cardanico 3/8"		1
bussola 3/8" portainseri 1/4"		1

## 764 3/8" E22

**NEW**

**E031805P**

Assortimento bussole e accessori 3/8" (22 pz.)  
Fornito in cassetta compatibile con i cassettei dei carrelli 002

€ 81,90 **€ 49,00**



## 764 1/2" E22

**E032900P**

Assortimento bussole e accessori 1/2" (22 pz.)  
Fornito in cassetta compatibile con i cassettei dei carrelli 002

€ 81,20 **€ 49,00**



## 764 1/2" E42

**NEW**

**E032908P**

Assortimento bussole e accessori 1/2" (42 pz.)  
Fornito in cassetta compatibile con i cassettei dei carrelli 002

€ 160,65 **€ 96,00**



### Assortimento di 22 utensili

descrizione	art./mis.	pz.
chiavi a bussola 1/2"	8-10-11-12-13-14-15-16-17-18-19-21-22-24-27-30-32	17
cricchetto reversibile 1/2"		1
snodo cardanico 1/2"		1
prolunghe 1/2"	130-250	2
leva a T 1/2"		1

### Assortimento di 42 utensili

descrizione	art./mis.	pz.
bussole esagonali 1/2"	8-9-10-11-12-13-14-15-16-17-18-19-20-21-22-23-24-25-26-27-28-29-30-32	24
bussole esagonali lunghe 1/2"	12-13-14-15-16-17-18-19-21-22-24	11
cricchetto 1/2"		1
prolunghe 1/2"	130-250	2
snodo cardanico 1/2"		1
leva a T 1/2"		1
riduttore 1/2"-3/8"		1
aumentatore 3/8"-1/2"		1

## 764 1/2" TX E16

**NEW**

**E032907P**

Assortimento bussole Torx (16 pz.)  
Fornito in cassetta compatibile con i cassettei dei carrelli 002

~~€72,45~~ **€ 43,00**



## 764 1/4" E19

**E030700P**

Assortimento bussole e accessori 1/4" (19 pz.)  
Fornito in cassetta compatibile con i cassettei dei carrelli 002

~~€50,40~~ **€ 30,00**



### Assortimento di 16 utensili

descrizione	art./mis.	pz.
bussole con inserto Torx 1/2" ☸	T20-T25-T27-T30-T40-T45-T50-T55-T60	9
bussole Torx 1/2"	E10-E12-E14-E16-E18-E20-E24	7

### Assortimento di 19 utensili

descrizione	art./mis.	pz.
chiavi a bussola 1/4"	4-4,5-5-5,5-6-7-8-9-10-11-12-13-14	13
cricchetto reversibile 1/4"		1
snodo cardanico 1/4"		1
prolunghe 1/4"	55-100	2
leva a T 1/4"		1
raccordo portainseriti 1/4"		1

### Assortimento di 34 utensili

descrizione	art./mis.	pz.
chiavi a bussola 1/4"	4-4,5-5-5,5-6-7-8-9-10-11-12-13-14	13
cricchetto reversibile 1/4"		1
snodo cardanico 1/4"		1
prolunghe 1/4"	55-100	2
inserti ad intaglio ☯	4-5,5-6	3
inserti a croce Pozidriv ☸	1-2-3	3
inserti esagono maschio ⬤	4-5-6	3
inserti Torx ☸	10-15-20-25-30-40	6
impugnatura maschio/femmina		1
raccordo portainseriti 1/4"		1

## 764 1/4" E34

**E194672P**

Assortimento bussole e accessori 1/4" (34 pz.)  
Fornito in cassetta compatibile con i cassettei dei carrelli 002

~~€58,30~~ **€ 35,00**



## 764 1/4" E42

**NEW**

**E030702P**

Assortimento bussole e accessori 1/4" (42 pz.)  
Fornito in cassetta compatibile con i cassettei dei carrelli 002

~~€75,60~~ **€ 45,00**



### Assortimento di 42 utensili

descrizione	art./mis.	pz.
bussole esagonali 1/4"	4-4,5-5-5,5-6-7-8-9-10-11-12-13-14	13
bussole con inserto 1/4" ☯	4-5,5-7	3
bussole con inserto Torx 1/4" ☸	T10-T15-T20-T25-T30-T40	6
bussole con inserto Phillips 1/4" ☇	PH1-PH2-PH3	3
bussole con inserto Pozidriv 1/4" ☸	PZ1-PZ2-PZ3	3
bussole con inserto esagonale 1/4" ⬤	3-4-5-6-7-8	6
cricchetto 1/4"		1
prolunghe 1/4"	55-100-150	3
snodo cardanico 1/4"		1
leva a T 1/4"		1
impugnatura con quadro maschio 1/4"		1
adattatore 1/4" portainseriti 1/4"		1

**764 1/4"-1/2" E98**

**NEW**

**E034805P**

Assortimento bussole e accessori 1/4"-1/2" (98 pz.)  
Fornito in cassetta compatibile con i cassettei dei carrelli 002

€ 174,70

**€ 97,00**



**Assortimento di 98 bussole e accessori**

descrizione	art./mis.	pz.
bussole esagonali 1/4"	4-5-5,5-6-7-8-9-10-11-12-13	11
bussole esagonali lunghe 1/4"	6-8-10-11-12-13-14	7
inserti Torx 1/4"	T6-T8-T10	3
bussole con inserto 1/4" ⚙	4-7	2
bussole con inserto Torx 1/4" ⚙	T8-T10-T15-T20-T25-T27-T30	7
bussole con inserto Phillips 1/4" ⚙	PH1-PH2	2
bussole con inserto Pozidriv 1/4" ⚙	PZ1-PZ2	2
bussole con inserto esagonale 1/4"	3-4-5-6	4
cricchetto 1/4"		1
prolunghe 1/4"	55-100	2
snodo cardanico 1/4"		1
leva a T 1/4"		1
impugnatura con quadro maschio 1/4"		1
bussole esagonali 1/2"	10-11-12-13-14-15-16-17-18-19-20-21-22-24-27-30-32	17
bussole esagonali lunghe 1/2"	14-15-17-19-22	5
bussole per candele 1/4"	16-21	2
bussole Torx 1/2"	E12-E14-E16-E18-E20-E24	6
cricchetto 1/2"		1
aumentatore 3/8"-1/2"		1
bussola 1/2" portainseriti 5/16"		1
prolunghe 1/2"	130-250	2
snoda cardanico 1/2"		1
inserti XZN 5/16"	6-8-10-12	4
inserti 5/16" ⚙	8-12	2
inserti Torx 5/16" ⚙	T40-T45-T50-T55	4
inserti Phillips 5/16" ⚙	PH3-PH4	2
inserti Pozidriv 5/16" ⚙	PZ3-PZ4	2
inserti esagonali 5/16" ⚙	8-10-12-14	4

**764 1/4"-1/2" E101**

**NEW**

**E032911P**

Assortimento bussole, chiavi e accessori 1/4"-1/2" (101 pz.)  
Fornito in cassetta compatibile con i cassettei dei carrelli 002

€ 256,20

**€ 154,00**



**Assortimento di 101 utensili**

descrizione	art./mis.	pz.
bussole esagonali 1/4"	4-4,5-5-5,5-6-7-8-9-10-11-12-13-14	13
bussole con inserto 1/4" ⚙	4-5,5-7	3
bussole con inserto Torx 1/4" ⚙	T8-T10-T15-T20-T25-T27-T30	7
bussole con inserto Phillips 1/4" ⚙	PH1-PH2	2
bussole con inserto Pozidriv 1/4" ⚙	PZ1-PZ2	2
bussole con inserto esagonale 1/4"	3-4-5-6	4
cricchetto 1/4"		1
prolunghe 1/4"	55-100	2
snodo cardanico 1/4"		1
leva a T 1/4"		1
impugnatura con quadro maschio 1/4"		1
adattatore 1/4" portainseriti 1/4"		1
bussole esagonali 1/2"	10-11-12-13-14-15-16-17-18-19-20-21-22-24-27-30-32	17
bussole esagonali lunghe 1/2"	13-17-19	3
bussole per candele 1/4"	16-21	2
cricchetto 1/2"		1
bussola 1/2" portainseriti 5/16"		1
prolunghe 1/2"	130-250	2
snodo cardanico 1/2"		1
leva a T 1/2"		1
inserti 5/16" ⚙	8-12	2
inserti Torx 5/16" ⚙	T40-T45-T50-T55	4
inserti Phillips 5/16" ⚙	PH3-PH4	2
inserti Pozidriv 5/16" ⚙	PZ3-PZ4	2
inserti esagonali 5/16" ⚙	12-14	2
chiavi maschio	1,5-2-2,5-3-4-5-6-7-8-9-10	11
chiavi combinate	7-8-10-11-12-13-14-15-16-17-18-19	12



**528 S9****NEW**

E113929P   
 Serie di chiavi maschio esagonale piegate  
 fornita con supporto in plastica  
 Dimensioni: 1,5-2-2,5-3-4-5-6-8-10 mm

~~€11,95~~ **€ 7,00**

**528 SE8**

528SE008   
 Serie di chiavi maschio esagonale  
 Supporto tascabile in acciaio  
 con guanciali in plastica  
 Dimensioni: 1,5-2-2,5-3-  
 4-5-6-8 mm

~~€17,20~~ **€ 10,00**

**528 L S9****NEW**

E113947P   
 Serie di chiavi maschio esagonale lunghe piegate  
 fornita con supporto in plastica  
 Dimensioni: 1,5-2-2,5-3-4-5-6-8-10 mm

~~€13,05~~ **€ 8,00**

**528 TS S9****NEW**

E113976P  
 Serie di chiavi maschio esagonale lunghe piegate  
 con testa sferica, fornita con supporto in plastica  
 Dimensioni: 1,5-2-2,5-3-4-5-6-8-10 mm

~~€24,20~~ **€ 14,00**

**528 TX S7****NEW**

E121102P   
 Serie di chiavi maschio per viti  
 con im pronta Torx®  
 fornita con supporto in plastica  
 Dimensioni: T10-T15-T20-T25-T27-  
 T30-T40 mm

~~€34,20~~ **€ 20,00**



**528 TX H SE7**

E121103P 

Serie di chiavi maschio per viti con impronta Torx Tamper Resistant®

Supporto tascabile in acciaio con guanciali in plastica

Dimensioni: T10÷T40 mm

€27,10 **€ 17,00**



**528 P S7**

**NEW**

E121202P 

Serie di chiavi maschio esagonale piegate con impugnatura, fornita con supporto in plastica

Dimensioni: 2,5-3-4-5-6-8-10 mm

€52,55 **€ 31,00**



**528 TS P S6**

**NEW**

E121203P 

Serie di chiavi maschio esagonale piegate a testa sferica,

fornita con supporto in plastica

Dimensioni: 4-5-6-7-8-10 mm

€48,05 **€ 29,00**



**528 TX P S7**

**NEW**

E121301P 

Serie di chiavi maschio piegate con impugnatura per viti con impronta Torx®

Fornita con supporto in plastica

Dimensioni: T10-T15-T20-T25-T27-T30-T40 mm

€48,75 **€ 29,00**





### 81 N SE8

**881NSS08**  
Serie di chiavi a forchetta doppie  
in confezione appendibile  
Dimensioni: 6x7-8x9-10x11-  
12x13-14x15-16x17-  
18x19-20x22 mm

~~€32,25~~ € 20,00

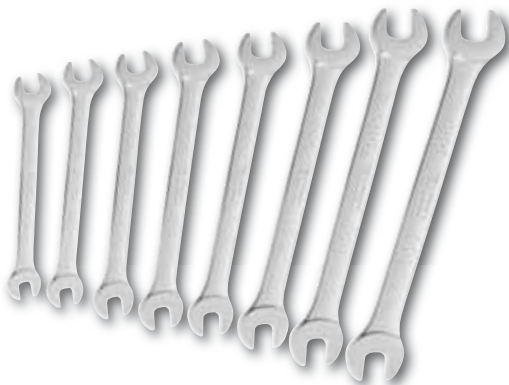

### 81 N SE8 **NEW**

**E111404P**  
Serie di chiavi a forchetta doppie  
in supporto di plastica  
Dimensioni: 6x7-8x9-10x11-12x13-14x15-  
16x17-18x19-20x22 mm

~~€34,90~~ € 21,00

### 81 N SE13 **NEW**

**E111405P**  
Serie di chiavi a forchetta doppie  
in supporto di plastica  
Dimensioni: 6x7-8x9-10x11-12x13-14x15-  
16x17-18x19-20x22-21x23-24x26-25x28-  
27x29-30x32 mm

~~€80,15~~ € 48,00



### 82 SE8 **NEW**

**882ASS08**  
Serie di chiavi poligonali doppie curve  
Dimensioni: 6x7-8x9-10x11-12x13-14x15-  
16x17-18x19-20x22 mm

~~€61,95~~ € 37,00

### 82 S12 **NEW**

**882AS012**  
Serie di chiavi poligonali doppie curve  
Dimensioni: 6x7-8x9-10x11-12x13-14x15-  
16x17-18x19-20x22-21x23-24x26-25x28-  
30x32 mm

~~€124,30~~ € 74,00

### 82 S13 **NEW**

**882AS013**  
Serie di chiavi poligonali doppie curve  
Dimensioni: 6x7-8x9-10x11-12x13-14x15-  
16x17-18x19-20x22-21x23-24x26-25x28-  
27x29-30x32 mm

~~€142,70~~ € 86,00

### 83 C SE7 **NEW**

**E110304P**  
Serie di chiavi combinate corte  
fornita con supporto di materiale plastico  
Dimensioni: 10-12-13-14-15-  
17-19 mm

~~€29,00~~ € 17,00







**83 N S12**

**NEW**

**E110301P**

Serie di chiavi combinate  
in confezione appendibile  
Dimensioni: 7-8-10-11-12-13-16-  
17-18-19-22-24 mm

~~€78,40~~ **€ 47,00**

**83 N S8**

**NEW**

**E110300P**

Serie di chiavi combinate  
in confezione appendibile  
Dimensioni: 8-10-11-13-17-19-22-24 mm

~~€55,30~~ **€ 33,00**

**83 N S18**

**NEW**

**E113240P**

Serie di chiavi combinate  
in confezione appendibile  
Dimensioni: 6-7-8-9-10-11-12-13-14-  
15-16-17-18-19-20-21-22-24 mm

~~€116,75~~ **€ 70,00**

**83 N SE8**

**NEW**

**E110307P**

Serie di chiavi combinate  
in supporto di plastica  
Dimensioni: 8-10-11-13-14-  
17-19-22 mm

~~€51,85~~ **€ 31,00**



**83 N SE13**

**NEW**

**E110308P**

Serie di chiavi combinate  
in supporto di plastica  
Dimensioni: 7-8-10-12-13-14-17-19-  
22-24-27-30-32 mm

~~€117,00~~ **€ 70,00**

**83 N SE17**

**NEW**

**883NSE10**

Serie di chiavi combinate  
in supporto in lamiera  
Dimensioni: 6-7-8-9-10-11-12-13-  
14-15-16-17-18-19-20-21-22 mm

~~€120,20~~ **€ 72,00**



**83 N S26**

**NEW**

**883ASN26**

Serie di chiavi combinate  
Dimensioni: 6-7-8-9-10-11-12-13-14-15-16-17-18-19-20-  
21-22-23-24-25-26-27-28-29-30-32 mm

~~€229,03~~ **€ 137,00**

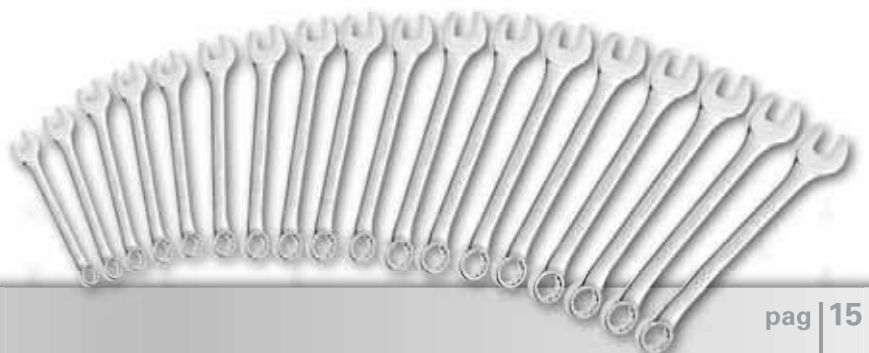

**83 N SB9****NEW****883ASNB9**

Serie di chiavi combinate in busta

Dimensioni: 6-7-8-10-11-13-14-17-19 mm

~~€54,50~~ **€ 33,00****83 N SB17****NEW****883ASNB7**

Serie di chiavi combinate in busta

Dimensioni: 6-7-8-9-10-11-12-13-14-15-16-17-18-19-20-21-22 mm

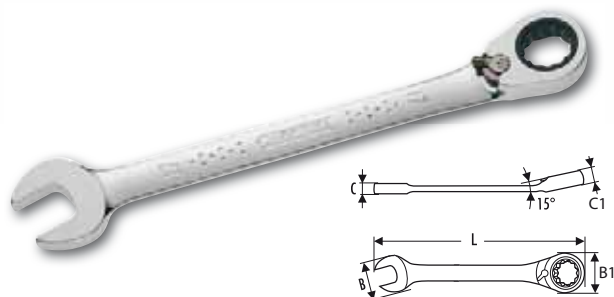
~~€117,80~~ **€ 71,00****83 K****NEW**Chiavi combinate a cricchetto reversibile  
ISO 691 - ISO 1711-1

Angolo di ripresa 5°

Testa a forchetta inclinata di 15° rispetto all'asse  
dell'impugnatura (angolo di ripresa 30°)

Testa poligonale a cricchetto piegata a 15°

Corpo forgiato in acciaio al cromo vanadio

Finitura cromata lucida

codice	A (mm/")	L (mm)	B (mm)	B1 (mm)	C (mm)	C1 (mm)	<del></del>	<del></del>
E117377P	6	124	16,3	17,7	5,1	7	<del>13,00</del>	<b>8,00</b>
E117378P	7	124	16,3	17,7	5,1	7	<del>13,50</del>	<b>8,00</b>
E113301P	8	135	18,5	17,7	5,1	7	<del>14,30</del>	<b>9,00</b>
E113302P	9	142	20,5	19,1	5,3	7	<del>14,50</del>	<b>9,00</b>
E113303P	10	158	22,5	21,2	5,8	8	<del>14,55</del>	<b>9,00</b>
E113300P	11	167	25	22,6	5,9	8	<del>14,70</del>	<b>9,00</b>
E113304P	12	173	26,9	23,8	6,1	8	<del>14,80</del>	<b>9,00</b>
E113305P	13	179	29	25,9	6,6	8	<del>15,75</del>	<b>10,00</b>
E113306P	14	189	31,5	27,7	7,5	9	<del>15,95</del>	<b>10,00</b>
E113307P	15	199	34	29,2	7,9	9	<del>17,25</del>	<b>10,00</b>
E113308P	16	215	35,7	31,8	7,9	9	<del>17,75</del>	<b>11,00</b>
E113309P	17	232	38,3	34,1	8	10	<del>18,80</del>	<b>11,00</b>
E113310P	18	238	40,1	34,0	8,5	11	<del>19,30</del>	<b>12,00</b>
E113311P	19	247	42	35,1	8,9	11	<del>20,80</del>	<b>12,00</b>
E117370P	21	285	45,3	41,5	10,3	13	<del>21,15</del>	<b>13,00</b>
E117371P	22	285	45,3	41,5	10,3	13	<del>21,65</del>	<b>13,00</b>
E117372P	24	325	52	47,0	10,8	14	<del>24,85</del>	<b>15,00</b>
E117373P	27	359	58,6	52,0	12,5	15	<del>46,20</del>	<b>28,00</b>
E117374P	30	425	64,5	59,5	13	17	<del>51,20</del>	<b>31,00</b>
E113460P	32	425	64,5	59,5	13	17	<del>59,45</del>	<b>36,00</b>

**83 K SE5****NEW****883KSS05**Serie di chiavi combinate a cricchetto  
reversibile in confezione appendibile

Dimensioni: 8-10-13-17-19 mm

~~€84,29~~ **€ 51,00**



**84 S5**

**884AS018**  
Serie di chiavi a T  
con snodo cardanico  
Dimensioni:  
8-10-13-17-19 mm

€137,50 **€ 83,00**

**84 S16**

**884S0011**  
Serie di chiavi a T  
con snodo cardanico  
Dimensioni: 6-7-8-9-  
10-11-12-13-14-15-  
16-17-18-19-20-22 mm

€437,85 **€ 263,00**



**85 S17**

**885AS017**  
Serie di 17 chiavi a T semplici  
Dimensioni: 6-7-8-9-10-11-12-  
13-14-15-16-17-18-19-20-21-22 mm

€333,55 **€ 200,00**

**86 S14**

**885AS014** ○  
Serie di chiavi a T  
con maschio esagonale  
Dimensioni: 2-2,5-3-3,5-  
4-4,5-5-6-7-8-9-10-12-14 mm

€262,05 **€ 157,00**

**86 S8**

**886S0004** ○  
Serie di chiavi a T  
con maschio esagonale  
Dimensioni: 2-2,5-  
3-4-5-6-8-10 mm

€129,25 **€ 78,00**



**86 S6**

**886ASS06** ○  
Serie di chiavi a T  
con maschio esagonale  
in confezione appendibile  
Dimensioni: 2-2,5-3-4-5-6 mm

€86,45 **€ 52,00**



## 86 C/S5

886S0004 ○

Serie di chiavi a T snodate con maschio esagonale

Dimensioni: 3-4-5-6-8 mm

€126,25 **€ 76,00**



## 86 TX S7

886TXSS7 ⚙

Serie di chiavi a T per viti con impronta Torx®

Dimensioni: T10-T15-T20-T25-T27-T30-T40 mm

€128,40 **€ 77,00**



## 88 S8

888S0005

Serie di chiavi a tubo doppie

Dimensioni: 6x7-8x9-10x11-12x13-14x15-16x17-18x19-20x22 mm

€54,90 **€ 33,00**

## 88 S12

888S0008

Serie di chiavi a tubo doppie

Dimensioni: 6x7-8x9-10x11-12x13-14x15-16x17-18x19-20x22-21x23-24x26-25x28-30x32 mm

€110,85 **€ 66,00**

## 88 S13

888AS013

Serie di chiavi a tubo doppie

Dimensioni: 6x7-8x9-10x11-12x13-14x15-16x17-18x19-20x22-21x23-24x26-25x28-27x29-30x32 mm

€126,30 **€ 76,00**

## 88 P S5

NEW

888PS011

Serie di chiavi a pipa passanti doppie

Dimensioni: 8-10-13-17-19 mm

€65,85 **€ 39,00**

## 88 P S17

NEW

888PS010

Serie di chiavi a pipa passanti doppie

Dimensioni: 6-7-8-9-10-11-12-13-14-15-16-17-18-19-20-21-22 mm

€235,65 **€ 141,00**



**79 S**
**NEW**

Chiavi a settore snodate  
 Capacità da 19 a 159 mm  
 Corpo forgiato in acciaio al cromo vanadio  
 Finitura cromata lucida

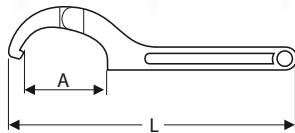

codice	A mm	L mm	<del>€</del>	€
E112601P	19-51	165	22,35	13,00
E112602P	32-76	216	28,95	17,00
E112603P	51-121	267	40,10	24,00
E112604P	114-159	308	51,75	31,00

**31 1/4" I**
**NEW**

**E030601P**  
 Cricchetto reversibile  
 ISO 3315 - DIN 3122  
 Meccanismo a 72 denti. Angolo di ripresa 5°  
 Testa compatta. Finitura cromata lucida  
 Impugnatura ergonomica bimateriale

~~€26,05~~ € 16,00

**31 3/8" I**
**NEW**

**E031701P**  
 Cricchetto reversibile  
 ISO 3315 - DIN 3122  
 Meccanismo a 72 denti. Angolo di ripresa 5°  
 Testa compatta. Finitura cromata lucida  
 Impugnatura ergonomica bimateriale

~~€29,15~~ € 17,00

**31 1/2" I**
**NEW**

**E032801P**  
 Cricchetto reversibile  
 ISO 3315 - DIN 3122  
 Meccanismo a 72 denti. Angolo di ripresa 5°  
 Testa compatta. Finitura cromata lucida  
 Impugnatura ergonomica bimateriale

~~€35,85~~ € 21,00



### 31 1/4" R

E113770P

Cricchetto reversibile. ISO 3315 - DIN 3122  
Meccanismo a 72 denti. Angolo di ripresa 5°  
Blocco di sicurezza per la bussola  
Inversione tramite leva. Finitura cromata lucida  
Impugnatura ergonomica bimatériale

~~€28,90~~ € 18,00



### 31 3/8" R

E113848P

Cricchetto reversibile. Meccanismo a 72 denti.  
Angolo di ripresa 5°. Blocco di sicurezza per la bussola  
Inversione tramite leva. Finitura cromata lucida  
Impugnatura ergonomica bimatériale

~~€32,90~~ € 20,00



### 31 1/2" R

E113708P

Cricchetto reversibile  
ISO 3315 - DIN 3122  
Meccanismo a 72 denti. Angolo di ripresa 5°  
Blocco di sicurezza per la bussola  
Inversione tramite leva. Finitura cromata lucida  
Impugnatura ergonomica bimatériale

~~€39,90~~ € 24,00



### 31 3/4" R

NEW

E113819P

Cricchetto reversibile  
Meccanismo a 24 denti. Angolo di ripresa 15°  
Blocco di sicurezza per la bussola  
Acciaio al cromo vanadio. Finitura cromata opaca  
Fornito con asta di manovra

~~€105,00~~ € 63,00



### 31 1" R

NEW

E034601P

Cricchetto reversibile  
ISO 3315 - DIN 3122  
Blocco di sicurezza per la bussola  
Pulsante di sgancio rapido. Acciaio al cromo vanadio  
Finitura cromata opaca. Fornito con asta di manovra

~~€175,50~~ € 105,00







### 30 1/4" SE13

**NEW**

E194675P

Serie di 13 chiavi a bussola esagonali  
in confezione appendibile  
Dimensioni: 4-4,5-5-5,5-6-7-8-9-10-  
11-12-13-14 mm

~~€25,05~~ **€ 15,00**



### 30 1/2" SE16

**NEW**

E032902P

Serie di 16 chiavi a bussola esagonali  
in confezione appendibile  
Dimensioni: 10-11-12-13-14-15-16-17-18-19-21-22-24-27-30-32 mm

~~€49,75~~ **€ 31,00**



### 39 N 1/2" SE8

83912SE4

Serie di 8 chiavi a bussola maschio per viti con esagono incassato  
Dimensioni: 5-6-7-8-10-12-14-17 mm

~~€54,75~~ **€ 39,00**



### 39 N 1/2" TX SE9

839ASNT2

Serie di 9 chiavi a bussola per viti con impronta TORX®  
Dimensioni: T20-T25-T27-T30-T40-T45-T50-T55-T60 mm

~~€110,85~~ **€ 64,00**

### 390 S18

E113901P 

Box inserti (19 pz.)  
18 inserti con portainseriti  
magnetico

~~€16,90~~ **€ 9,00**



#### Assortimento di 18 inserti

descrizione	art./mis.	pz.
inserti ad intaglio	4-4,5-5,5	3
inserti a croce Phillips®	PH 1-2	2
inserti a croce Pozidriv®	PZ 1-2-3	3
inserti esagono maschio	3-4-5-6	4
inserti Torx®	T 10-15-20-25-30-40	6

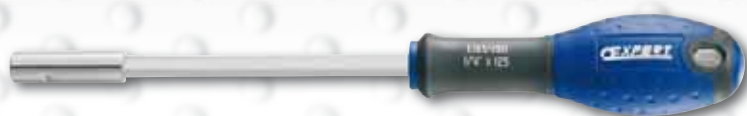
**390 P****NEW****E165490P**

Giravite portainseri magnetico 1/4"  
ISO 1173 - DIN 3126  
Impugnatura ergonomica bimateriale

~~€8,80~~ **€ 5,00****390 R****NEW****E160801P**

Giravite portainseri a cricchetto

Può contenere fino a 6 inserti

Apertura per pressione simultanea di due pulsanti

Contiene: inserti per viti con intaglio 4-5,5-6, inserti per viti  
Phillips® PH1, PH2, inserti per viti Pozidriv® PZ1, PZ2~~€24,45~~ **€ 15,00****390 RR****NEW****E160802P**

Giravite portainseri a cricchetto pieghevole

Può contenere fino a 6 inserti

Apertura per pressione simultanea di due pulsanti

Utilizzabile in due posizioni: tradizionale e piegata

Contiene: inserti per viti con intaglio 4-5,5-6, inserti per viti  
Phillips® PH1, PH2, inserti per viti Pozidriv® PZ1, PZ2~~€26,00~~ **€ 15,00****390 RR****NEW****E160803P** Giravite portainseri a cricchetto tipo corto  
ISO 1173Contiene un inserto per viti con intaglio 5,5,  
un inserto per viti Phillips® PH2,  
un inserto per viti Pozidriv® PZ2~~€30,90~~ **€ 18,00**



### 390 S30

**E131702P**   
Box inserti (32 pz.)  
30 inserti con portainseri  
magnetico e cricchetto

€41,40 **€ 23,00**

#### Assortimento di 30 inserti

descrizione	art./mis.	pz.
inserti ad intaglio	4-5-5-6,5-8	4
inserti a croce Phillips®	PH 1-2-3	3
inserti a croce Pozidriv®	PZ 1-2-3	3
inserti esagono maschio	3-4-5-6	4
inserti Torx Tamper Resistant®	STX 10-15-20-25-27-30-40	7
inserti Torx®	T 8-10-15-20-20-25-25-30-40	9

### 390 S48

**E131701P**   
Box inserti (49 pz.)  
48 inserti con portainseri magnetico

€32,00 **€ 21,00**

#### Assortimento di 36 pezzi

descrizione	art./mis.	pz.
inserti ad intaglio	4-4,5-5,5-6,5-6,5-8	6
inserti a croce Phillips®	PH 1-1-2-2-2-3	6
inserti a croce Pozidriv®	PZ 1-1-2-2-2-3-3	7
inserti esagono maschio	2-3-3-4-4-5-5-6-6	9
inserti Torx Tamper Resistant®	STX 10-15-15-20-20-25-25-30-30-40	10
inserti Torx®	T 10-10-15-15-20-20-25-25-30-30	10



### 390 S39

**NEW**

**E131705P**   
Box inserti  
e bussole 1/4" (39 pz.)  
29 inserti con portainseri  
magnetico e cricchetto  
7 bussole 1/4"  
con adattatore

€51,50 **€ 31,00**

#### Assortimento di 36 pezzi

descrizione	art./mis.	pz.
inserti ad intaglio	4-5,5-6,5-8	4
inserti a croce Phillips®	PH 1-2-2-3	4
inserti a croce Pozidriv®	PZ 1-2-3	3
inserti esagono maschio	3-4-5-6	4
inserti Torx®	T 8-10-15-20-25-30-40	7
inserti Torx Tamper Resistant®	STX 10-15-20-25-27-30-40	7
bussole 1/4"	6-7-8-10-11-12-13	7



## 384 SH6

384SS006 

Serie di giraviti in confezione appendibile  
Dimensioni: **384** 2,5x50-3x75-4x100-  
5,5x125m m; **384PH** 1x100-2x125 mm

€25,15 **€ 15,00**



## 384 S10

384SS010 

Serie di giraviti in confezione appendibile  
Dimensioni: **384** 2,5x50-3x75-4x100-  
5,5x125-6,5x150-6,5x30 mm;  
**384 PH** 0x75-1x100-2x125-2x30 mm

€44,15 **€ 26,00**

## 384 MZ/SE6

384MSS06 

Serie di giraviti isolati 1000V in confezione  
appendibile  
Dimensioni: **384 M** 2,5x50, 3,5x75, 4x100,  
5,5x150; **384 MPH** 1x100, 2x125

€33,45 **€ 20,00**



## 387 S11

387S0005 

Serie di chiavi a bussola esagonale  
con impugnatura  
Dimensioni: 4-5-5,5-6-7-8-9-10-11-12-13  
mm

€142,00 **€ 85,00**



## 184 SE8

184SE004 

Serie di 8 giraviti di precisione  
forniti in busta di plastica  
Dimensioni: **184** 0,8-1-1,4-1,6-2;  
**184 PH** 00-0-1

€57,55 **€ 34,00**



## 183 SH9

**NEW**

E161109P 

Giravite di precisione con lama inter-  
cambiabile e manico con serbatoio  
Composto di 8 lame con dimensioni  
1,0x40-1,2x40-1,5x40-1,8x40-2,0x40-  
2,5x40, PH 000-00

€14,40 **€ 9,00**

**299 B**

**NEW**

E117763P

Coltello per elettricisti con lama  
in acciaio inox e impugnatura in legno

~~€10,00~~ € 6,00



**393 N**

**NEW**

E161101P

100/500 Volts  
Dimensione lama: 3x66 mm

~~€5,00~~ € 3,00



**395 B**

395B0001

Multimetro digitale  
Guscio protettivo in gomma  
Display digitale ad alta visibilità  
Autospegnimento  
Data Hold: memoria automatica del picco  
Misura di tensione continua e alternata (Volt - V)  
Misura della corrente continua e alternata (Ampere - A)  
Misure di resistenza (Hom)  
Misure di capacità (F)  
Misura di temperatura con sonda esterna termocoppia  
Misura di hFE (diodi)

~~€97,55~~ € 58,00



**331 N**

Pinze a becchi diritti per anelli elastici interni

codice	capacità ø mm	lunghezza mm	<del>€</del>	€
E117912P	8÷12	155	€16,65	€ 10,00
E117913P	12÷25	155	€15,00	€ 9,00
E117914P	19÷60	190	€16,05	€ 10,00
E117915P	40÷100	225	€19,35	€ 11,00



**332 N**

Pinze a becchi piegati per anelli elastici interni

codice	capacità ø mm	lunghezza mm	<del>€</del>	€
E117920P	8÷12	145	€18,55	€ 11,00
E117921P	12÷25	145	€15,95	€ 10,00
E117922P	19÷60	180	€17,75	€ 11,00
E117923P	40÷100	215	€21,25	€ 13,00





### 333 N

Pinze a becchi diritti per anelli elastici esterni 

codice	capacità ø mm	lunghezza mm	<del>€17,15</del>	€ 10,00
E117908P	3÷10	155	<del>€17,15</del>	€ 10,00
E117909P	10÷25	155	<del>€15,15</del>	€ 9,00
E117910P	19÷60	190	<del>€16,80</del>	€ 10,00
E117911P	40÷100	225	<del>€20,85</del>	€ 12,00



### 334 N

Pinze a becchi piegati per anelli elastici esterni 

codice	capacità ø mm	lunghezza mm	<del>€19,60</del>	€ 12,00
E117916P	3÷10	145	<del>€19,60</del>	€ 12,00
E117917P	10÷25	145	<del>€16,70</del>	€ 10,00
E117918P	19÷60	180	<del>€18,20</del>	€ 11,00
E117919P	40÷100	215	<del>€22,70</del>	€ 14,00

### 370

Tronchesi a tagliente raso diagonale per materiale plastico 

codice	A mm	C mm	D mm	H mm	<del>€27,20</del>	€ 16,00
37000140	150	18	10	20	<del>€27,20</del>	€ 16,00
37000160	175	23	12	25	<del>€30,20</del>	€ 18,00

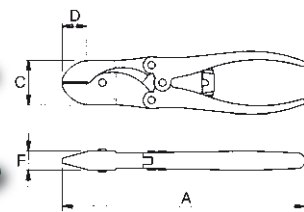

### 371

37100150   
Tronchese a tagliente raso obliquo per materiale plastico

€48,75 € 29,00

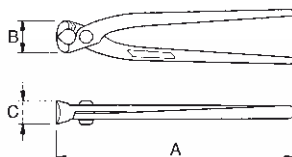

codice	A mm	B ø mm	C mm	<del>€14,70</del>	€ 9,00
E184179P	200	28	20	<del>€14,70</del>	€ 9,00
E184302P	230	31	23	<del>€15,45</del>	€ 9,00
E184181P	250	35	25	<del>€17,60</del>	€ 11,00
E184182P	280	35	25	<del>€19,30</del>	€ 12,00

### 505

Tenaglie per cementisti  
ISO 9242

Corpo in acciaio al carbonio  
Ganasce sottoposte  
a doppio trattamento  
termico (60-62 HRC)  
Manici arrotondati e semi rigidi  
Finitura brunita, testa pulita





**511 A**

**NEW**

Pinza regolabile semi-automatica  
ISO 8976  
Modello a 17 posizioni,  
regolabile grazie a un perno a pulsante  
Impugnatura ergonomica bimateriale  
Finitura fosfatata



codice	L mm	Profondità ganasce mm
E084648P	260	316
E084649P	311	695

~~€30,10~~ € 18,00  
~~€34,50~~ € 21,00



**514 M**

**NEW**

E084294P  
Pinza regolabile a cerniera chiusa 1000 V  
CEI 60900 - ISO 8976  
Sette posizioni di regolazione  
Impugnatura ergonomica bimateriale  
Finitura brunita

~~€23,15~~ € 14,00

**521**

**NEW**

Pinze regolabili autobloccanti con ganasce concave  
Corpo con cromatura anticorrosione  
Potenza di serraggio regolabile tramite rotella  
Leva di sbloccaggio

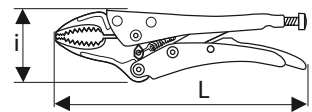

	L mm	i mm	profondità ganasce mm
E084807P	140	47	23
E084808P	190	60	34
E084809P	250	75	50

~~€15,40~~ € 9,00  
~~€17,70~~ € 11,00  
~~€20,75~~ € 12,00

**521 R10****NEW****E184199P**

Pinza regolabile autobloccante con doppia regolazione  
 Per il bloccaggio di profilati e angolari  
 Modello a 4 posizioni, regolabile grazie a un perno  
 Corpo con cromatura anticorrosione  
 Potenza di serraggio regolabile tramite rotella  
 Leva di sbloccaggio

~~€62,70~~ **€ 38,00****522 L****NEW**

Pinze regolabili autobloccanti con ganasce lunghe sottili  
 Permette un migliore accesso  
 Corpo con cromatura anticorrosione  
 Potenza di serraggio regolabile tramite rotella  
 Leva di sbloccaggio

codice	L mm	i mm	profondità ganasce mm
E084812P	170	47	51
E084813P	235	56	66

~~€20,50~~ **€ 12,00**  
~~€29,35~~ **€ 18,00**

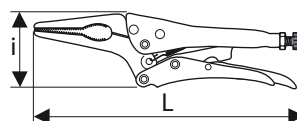
**524 N****NEW**

Pinze regolabili autobloccanti extra-lunghe  
 Per il bloccaggio di profilati e angolari  
 Corpo con cromatura anticorrosione  
 Potenza di serraggio regolabile tramite rotella  
 Leva di sbloccaggio

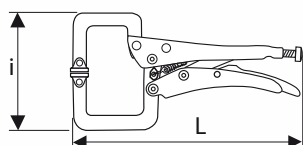

codice	L mm	i mm	profondità ganasce mm	altezza ganasce mm
E084815P	170	88	37	58
E084816P	290	150	65	100

~~€22,50~~ **€ 12,00**  
~~€29,20~~ **€ 17,00**

## 532

Scalpellini a profilo costante  
DIN7255  
Corpo in acciaio al cromo vanadio  
Lama riaffilabile

codice	A mm	B mm
E150702P	150	21
E150703P	200	24
E150704P	250	27



~~€ 11,10~~ € 7,00

~~€ 12,25~~ € 7,00

~~€ 14,30~~ € 9,00

## 532 P

**E150701P**  
Scalpellino extrapiatto  
DIN 7255  
Corpo in acciaio al cromo vanadio  
Lama riaffilabile

~~€ 12,00~~ € 7,00

## 544 N

Troncabulloni a tagliente centrale  
Ganasce forgiate al cromo molibdeno  
Capacità di taglio acciaio fino a 160 Kg/mm<sup>2</sup>  
Impugnature in PVC



codice	mm	Kg/mm	Kg/mm	130	d (mm) - 160 Kg/mm
<b>NEW</b> E195561P	300	6	4	3	<del>€ 29,00</del> € 17,00
E117750P	350	8	6	5	<del>€ 43,30</del> € 26,00
E117751P	450	8	6	6	<del>€ 55,25</del> € 33,00
E117752P	600	10	8	7	<del>€ 73,65</del> € 44,00
E117753P	750	11	10	8	<del>€ 93,15</del> € 56,00
E117754P	900	12	11	9	<del>€ 124,45</del> € 75,00
<b>NEW</b> E117755P	1050	14	12	10	<del>€ 135,00</del> € 81,00

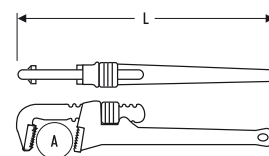

## 601 N

**NEW**

Giratubi modello americano  
Ganasce trattate per una elevata resistenza  
e una perfetta presa dei tubi  
Corpo in ghisa  
Ganascia fissa in acciaio forgiato

	A maxi mm	A maxi "	L mm	L "
E117820P	35	1	200	8
E117821P	54	1"1/2	250	10
E117822P	60	2	350	14
E117823P	76	2"1/2	450	18
E117824P	102	3"1/2	610	24
E117825P	140	5	920	36

~~€ 21,35~~ € 13,00  
~~€ 25,05~~ € 15,00  
~~€ 36,65~~ € 22,00  
~~€ 52,60~~ € 32,00  
~~€ 88,50~~ € 53,00  
~~€ 196,95~~ € 118,00

## 602 M

**NEW**

**E117829P**  
Tagliatubi per tubi in rame  
Spessore massimo tubi 16mm  
Regolazione tramite rotella  
Lama svasatubi incorporata  
Fornito con lama di ricambio

~~€ 10,30~~ € 6,00





**296 C****NEW****E117764P**

Forbice per telefonisti  
Lame corte rinforzate con tagliacavo  
Acciaio al carbonio  
Finitura cromata lucida  
Impugnatura in PVC

~~€11,50~~ **€ 7,00****296 XT****NEW****E184280P**

Forbice per elettricisti  
Lame lunghe con tagliacavo  
Acciaio inox  
Impugnatura ergonomica bimatereale

~~€12,50~~ **€ 8,00****296 XT****NEW****D296XT901A**

Forbice per elettricisti  
in confezione appendibile  
Lame lunghe con tagliacavo  
Acciaio inox  
Impugnatura ergonomica bimatereale

~~€13,05~~ **€ 8,00****297 B****NEW****E020901P**

Forbice multiuso  
Adatta a tagliare ogni tipo di materiale:  
cartone, plastica, cuoio 5 mm, lamiera sottile, cavi elettrici  
Garantisce un taglio netto e preciso grazie alle lame  
con microdentatura antiscivolo  
Leva di sicurezza per il bloccaggio delle lame  
Impugnatura ergonomica bimatereale  
Lunghezza lame: 58 mm

~~€20,75~~ **€ 12,00**

## 399 Q

Mazzuole antirimbalo con microsfero d'acciaio  
Corpo in monoblocco in materiale plastico-caucciù

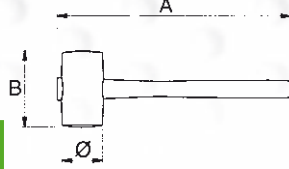

codice	Ø mm	A mm	B mm	€	€
E150115P	37,4	286	91,5	30,60	18,00
E150116P	54	370	132	35,70	21,00



## 399 P

Mazzuole  
Modello con tasselli intercambiabili in materiale plastico  
Testa in lega di acciaio zincato  
Manico in legno

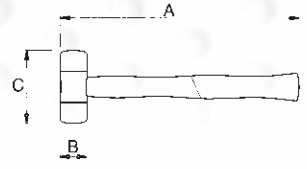

codice	A mm	B Ø mm	C mm	€	€
E150301P	270	27	90	13,65	8,00
E150302P	290	32	100	17,50	10,00
E150303P	330	40	110	26,00	17,00
E150304P	350	50	115	38,10	23,00



## 26 N

Chiavi dinamometriche a scatto  
Conformi alla norma ISO 6789  
Precisione ±4% tra 20% e 100% della capacità  
Resistenza alla fatica testata  
Disarmo percepibile al tatto e all'udito  
Riarmo automatico



codice	"	Capacità Nm	L mm	L mm	€	€
E113568P	1/4	5-25	330	28	117,50	70,00
E113565P	3/8	10-50	330	28	119,85	72,00
<b>NEW</b> E113105P	1/2	20-110	410	62	124,00	74,00
E113571P	1/2	40-210	510	36,5	127,95	76,00
E113572P	1/2	70-350	630	36,5	149,75	89,00
<b>NEW</b> E113100P	3/4	140-770	1040	36,5	401,00	240,00

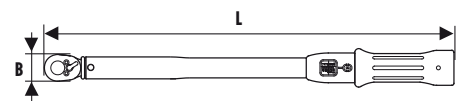

## 27

**NEW**

Moltiplicatori di coppia  
Per serraggi e disserraggi ad elevato valore di coppia  
Dispositivo di protezione in caso di superamento della capacità massima del meccanismo  
Leva di contrasto diritta  
Leva di contrasto a 90°

codice	"	"	Capacità Nm	€	€
E100103P	1/2	3/4	1500	573,00	344,00
E100104P	1/2	1	2500	787,00	472,00

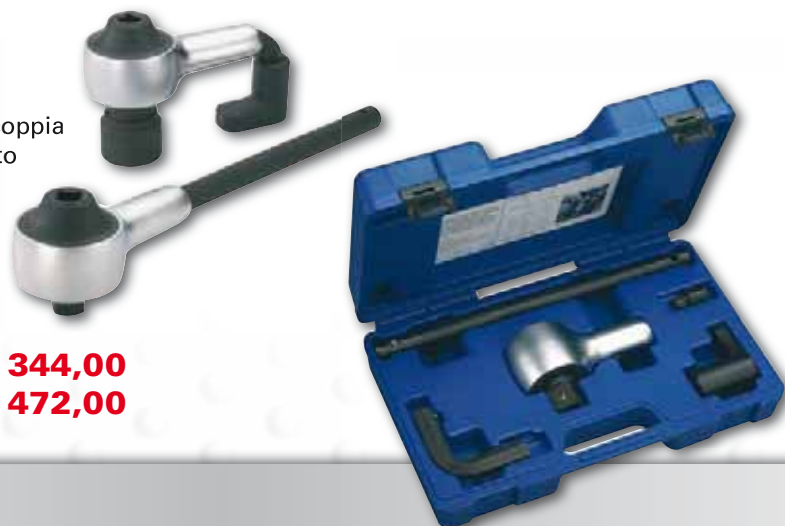

## 95

Estrattori a due bracci per esterni  
Bracci scorrevoli autoserranti  
Corpo in acciaio al cromo vanadio, cromato  
Vite in acciaio al carbonio, brunita

codice	No.	A max mm	B max mm	mm	<del>€</del>	€
89500000	0	65	70	14	€68,25	€ 41,00
89500001	1	90	110	17	€75,40	€ 45,00
89500002	2	130	110	17	€80,60	€ 48,00
89500003	3	175	165	22	€131,50	€ 79,00
89500004	4	220	165	22	€144,85	€ 87,00

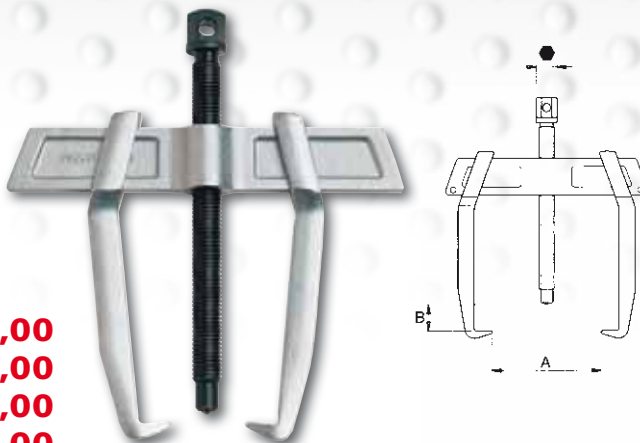

## A 040

**E200202P**  
Chiave per tappi olio Peugeot, Citroen e Renault  
■ 8-10 mm

~~€10,50~~ € 6,00



## A 041

**E200203P**  
Serie di 13 bussole per tappi olio con quadro di manovra 3/8":  
- 4 bussole con quadro maschio 8-10-10,5-13,1 mm  
- 6 bussole con profilo esagonale maschio 8-10-12-13-14-17 mm  
- 1 bussola con profilo triangolare maschio  
- 1 bussola con profilo XZN M 16  
- 1 bussola con quadro femmina 10 mm

~~€89,25~~ € 54,00



## A 050

**NEW**

Chiavi a bussola per candele  
ISO 11168

codice	d mm	lati mm	<del>€</del>	€
E200301P	14	12	€8,00	€ 5,00
E200302P	16	6	€8,00	€ 5,00
E200303P	21	6	€8,00	€ 5,00



## A 042

**E200201P**  
Serie composta da 28 chiavi  
a tazza con quadro di manovra 3/8",  
1 adattatore 3/8"-1/2", 1 chiave auto-  
serrante

~~€169,05~~ € 101,00





## A 130

### E200901P

Spurgatore per freni a depressione per autovetture e motocicli  
Utilizzabile per circuito frenante o frizione  
Principio Venturi  
Indicazione del valore della depressione attraverso manometro  
Capacità 4 l  
Pressione di esercizio 6-10 bars

~~€94,50~~ € 57,00



## A 131

### E200902P

Dispositivo per il riempimento automatico delle vaschette liquido freni  
Adattabile a tutti i diametri delle vaschette  
Capacità 1 litro  
Rubinetto di arresto

~~€47,25~~ € 28,00



## A 140

### E194676P

Serie di 3 bussole rivestite in plastica per cerchi in lega  
Misure 17-19-21 mm

~~€36,75~~ € 22,00



## A 330A

### E200101P

Sollevatore idraulico 2 t:  
- alzata min 108 mm  
- alzata max 413 mm  
- ruote in metallo  
- fornito completo di piattello in gomma e spugna sull'impugnatura per evitare danneggiamenti alla carrozzeria  
- modello compatto e leggero 25 kg  
- conforme alla norma EN1494

~~€278,25~~ € 165,00



## A 330B

### E200102P

Sollevatore idraulico 2 t extra piatto:  
- alzata min 80 mm  
- alzata max 375 mm  
- lunghezza utile 520 mm (altezza 90 mm)  
- ruote in metallo  
- fornito completo di piattello in gomma e spugna sull'impugnatura per evitare danneggiamenti alla carrozzeria  
- conforme alla norma EN1494

~~€471,45~~ € 279,00



## A 330C

E200103P

Sollevatore idraulico 3,2 t:

- alzata min 145 mm
- alzata max 504 mm
- ruote in metallo
- fornito completo di piattello in gomma e spugna sull'impugnatura per evitare danneggiamenti alla carrozzeria
- conforme alla norma EN1494

~~€ 345,45~~ € 205,00



## A 332

Coppia di colonnette con regolazione rapida a cremagliera



codice	portata t	altezza min mm	altezza max mm		
E200105P	3	292	432	<del>€ 60,90</del>	€ 36,00
E200106P	6	390	618	<del>€ 99,75</del>	€ 60,00
E200107P	12	445	700	<del>€ 198,45</del>	€ 119,00

## 89

88900000

Chiave a croce per dadi ruote

UNI-ISO6788

Cromata

Dimensioni: 17x19x22x■1/2"

~~€ 51,65~~ € 31,00



## 89 C

889C0004

Chiave a croce per dadi ruote

UNI-ISO 6788

Cromata

Dimensioni: 24x27x32x■3/4"

~~€ 117,70~~ € 71,00



**90**

89000225

Chiave a nastro sintetico per filtri olio

~~€16,15~~ **€ 10,00**



**90 NM**

**NEW**

E117117P

Chiave a nastro metallico per filtri olio da 60 a 110 mm

Adatta per la maggior parte dei filtri olio (VEICOLI LEGGERI)

~~€30,10~~ **€ 18,00**



**90 NMC**

**NEW**

E200219P

Chiave a nastro metallico per filtri olio da 110 a 165 mm

Adatta per la maggior parte dei filtri olio (VEICOLI INDUSTRIALI)

~~€30,00~~ **€ 19,00**

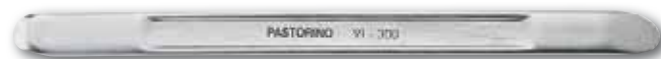

**91 N**

Leve per pneumatici  
Corpo in acciaio  
al cromo vanadio  
Cromate

codice	A mm	C mm
891N0001	300	22,0
891N0002	400	24,5
891N0003	500	26,0
891N0004	600	28,0

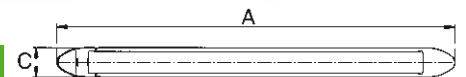

~~€15,25~~ **€ 9,00**  
~~€20,35~~ **€ 12,00**  
~~€30,10~~ **€ 18,00**  
~~€37,85~~ **€ 23,00**

**581**

**NEW**

E201401P

Lampada d'ispezione

80 Led (3200 Lux)

2 magneti rimovibili

Gancio rotante 360°

Autonomia 4 ore

(3h 200 lumens,

1h 80-100 lumens)

Carica rapida 3h

Batteria ricaricabile Ni-Mh

IP55

Dimensioni: 410x50 mm

~~€98,00~~ **€ 58,00**





**PASTORINO**  
EXPERT



# L'inizio di una nuova era

Nuovo catalogo

**PASTORINO**  
EXPERT



Nuovo catalogo PASTORINO EXPERT,  
Abbiamo fatto le cose in grande

[WWW.PASTORINO.IT](http://WWW.PASTORINO.IT)

SWK Utensilerie S.r.l.  
Via Volta,3 - 21020 Monvalle (VA) Italia  
tel. +39 0332 790283 - fax + 39 0332 790292

PREZZI NETTI IN EURO, IVA ESCLUSA  
AZIONE VALIDA FINO AL 31.12.2011

Le immagini riprodotte in questo catalogo sono indicative. SWK Utensilerie si riserva in ogni momento di modificare le caratteristiche tecniche dei propri prodotti

Y58020003

